

JAECO

316 MARINE GRADE PULL HANDLES



Features of Jaeco Pull Handles

- 316 Marine grade satin stainless steel construction
- Suitable for standard back to back installation
- Concealed grub screw fixing
- Custom sizes available on request

Mechanical Warranties: 10 years

Finishes



SS Stainless Steel



BK Matt Black

Technical Specifications

Door Thickness	Timber & Aluminium Door: 32mm to 70mm Glass Door: 10mm to 15mm
Door Type	Timber, Aluminium Door and Glass Door
Fixing Centres	Refer to Individual handle dimensions in next pages
Material	Stainless Steel 316SS
Accessibility	Compliant to the AS 1428:1-2009 Design for Access and Mobility

Fixing Detail

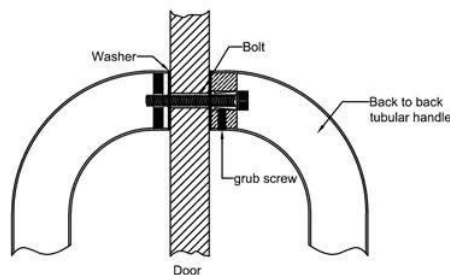

Back to back standard fixing



1701 Page 1



1708 Page 5



1704 Page 2



1709 Page 6



1705 Page 3



1710 Page 7



1707 Page 4



1714 Page 8

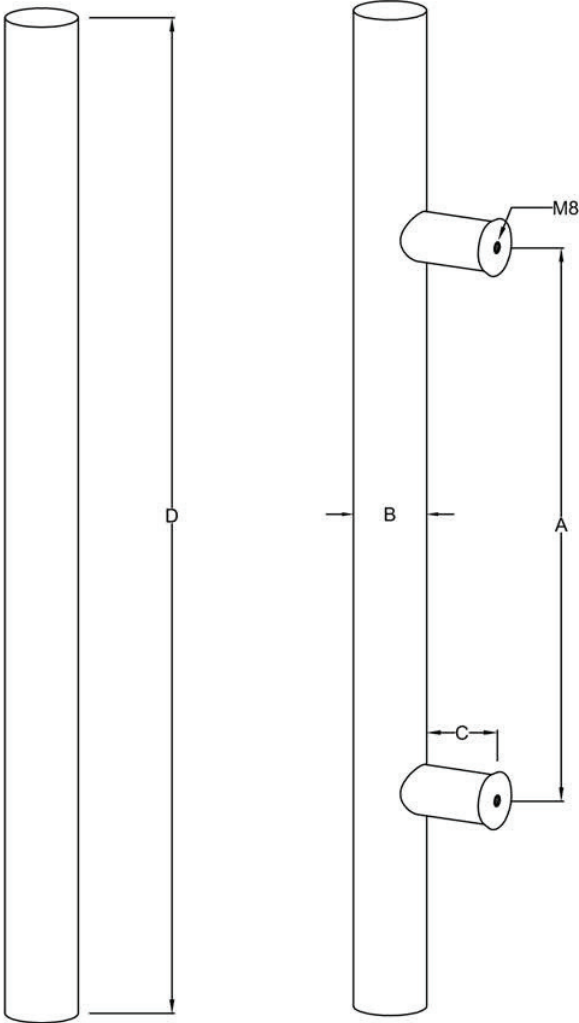

Fixing centres	Diameter	Clearance from door	Overall Length	Offset
A	B	C	D	E
250mm	32mm	35mm	450mm	
400mm	32mm	35mm	600mm	
600mm	32mm	35mm	800mm	
800mm	32mm	35mm	1000mm	
1000mm	32mm	35mm	1200mm	

Handle Projection = B + C

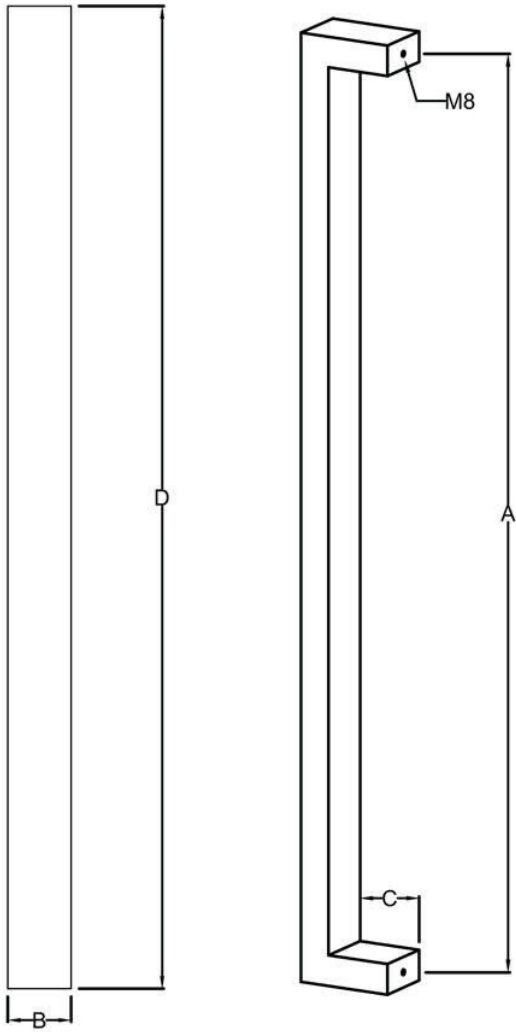
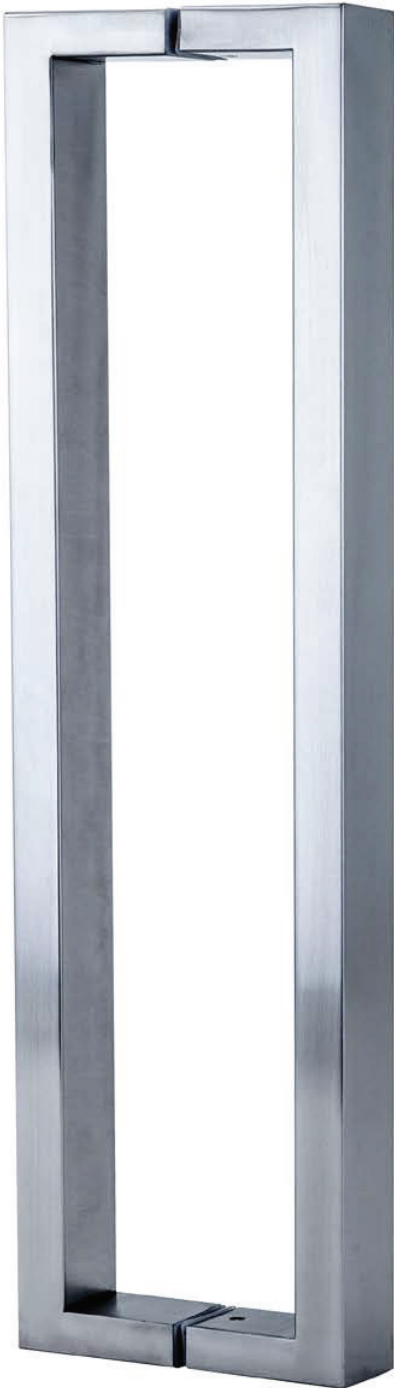

Fixing centres	Diameter	Clearance from door	Overall Length	Offset
A	B	C	D	E
600mm	40 x 20mm	42mm	620mm	
800mm	40 x 20mm	42mm	820mm	
1000mm	40 x 20mm	42mm	1020mm	

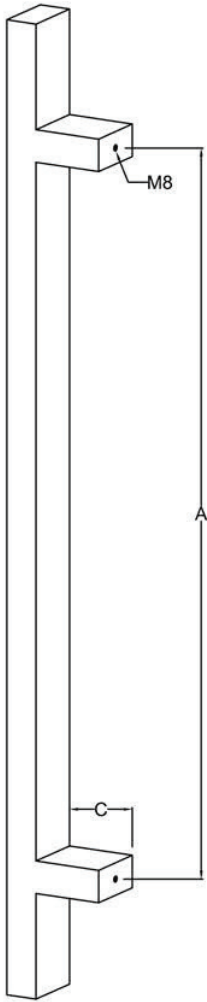
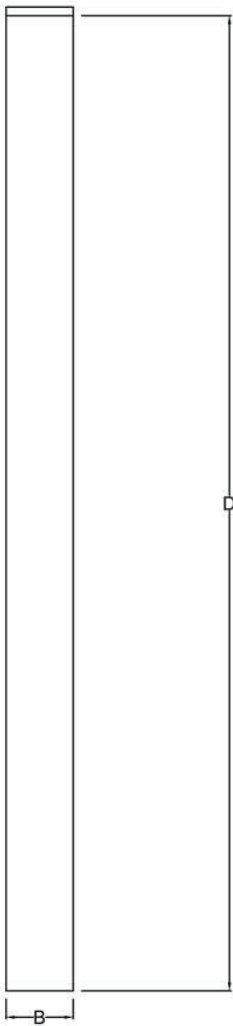

Fixing centres	Diameter	Clearance from door	Overall Length	Offset
A	B	C	D	E
450mm	25 x 25mm	50mm	600mm	
600mm	25 x 25mm	50mm	800mm	

Product Code: 1707

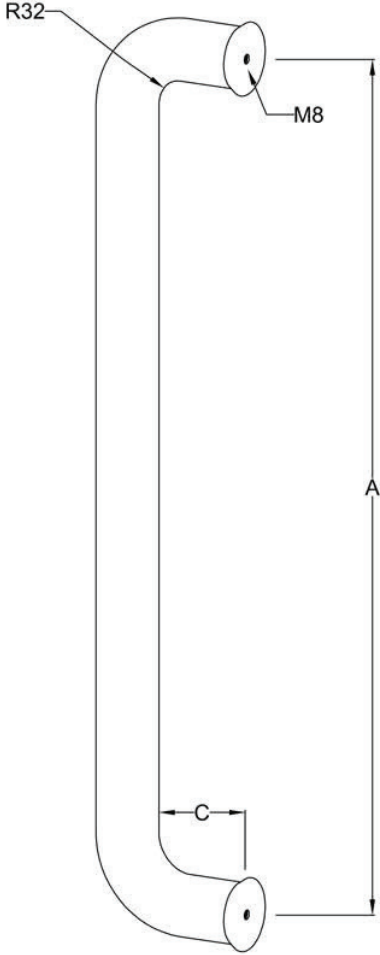
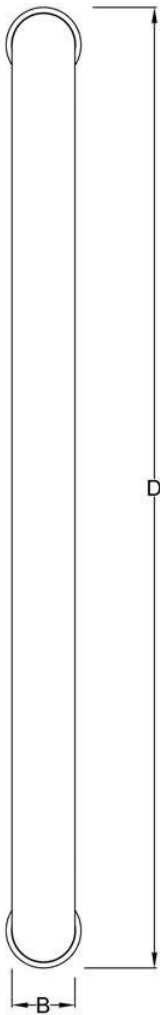

Fixing centres	Diameter	Clearance from door	Overall Length	Offset
A	B	C	D	E
300mm	32mm	52mm	332mm	
450mm	32mm	52mm	482mm	
600mm	32mm	52mm	632mm	
800mm	32mm	52mm	832mm	

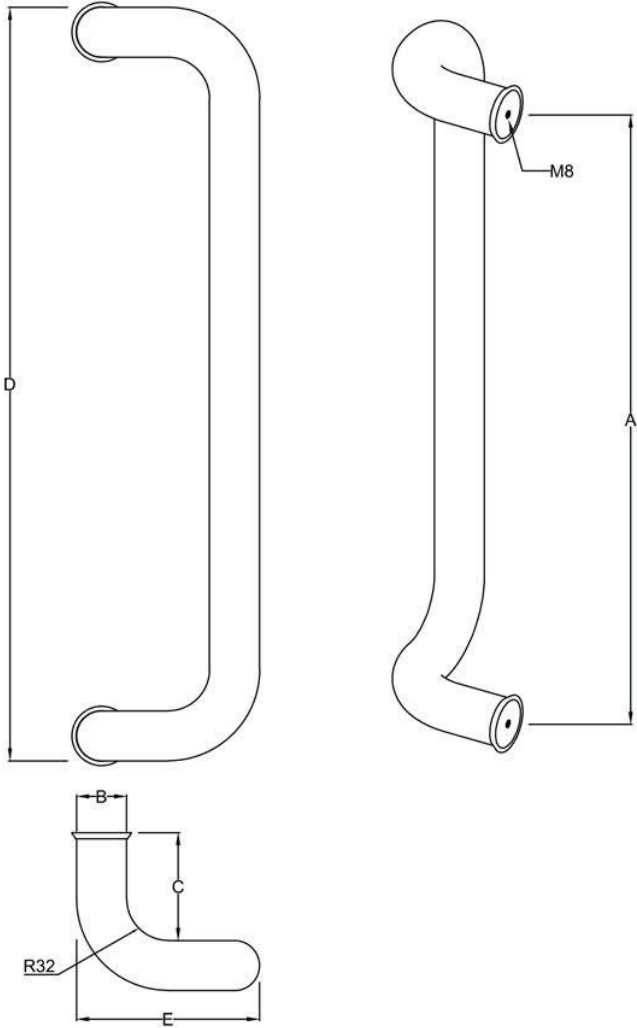

Fixing centres	Diameter	Clearance from door	Overall Length	Offset
A	B	C	D	E
300mm	32mm	50mm	332mm	132mm
450mm	32mm	50mm	482mm	132mm
600mm	32mm	50mm	632mm	132mm
800mm	32mm	50mm	832mm	132mm
1000mm	32mm	50mm	1032mm	132mm

Handle Projection = B + C

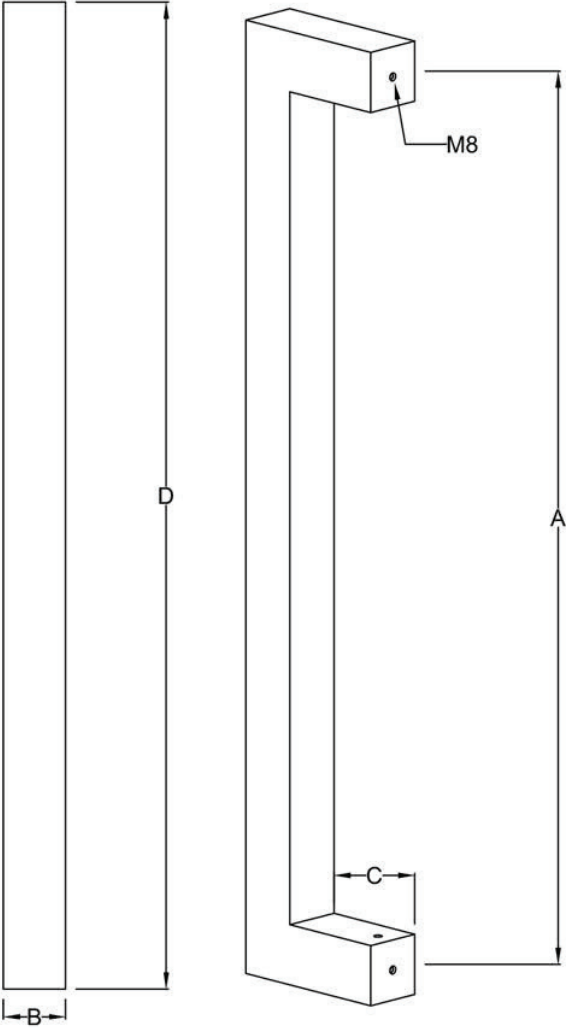

Fixing centres	Diameter	Clearance from door	Overall Length	Offset
A	B	C	D	E
300mm	25 x 25mm	45mm	325mm	
450mm	25 x 25mm	45mm	475mm	
600mm	25 x 25mm	45mm	625mm	
800mm	25 x 25mm	45mm	825mm	
1000mm	25 x 25mm	45mm	1025mm	

Handle Projection = B + C

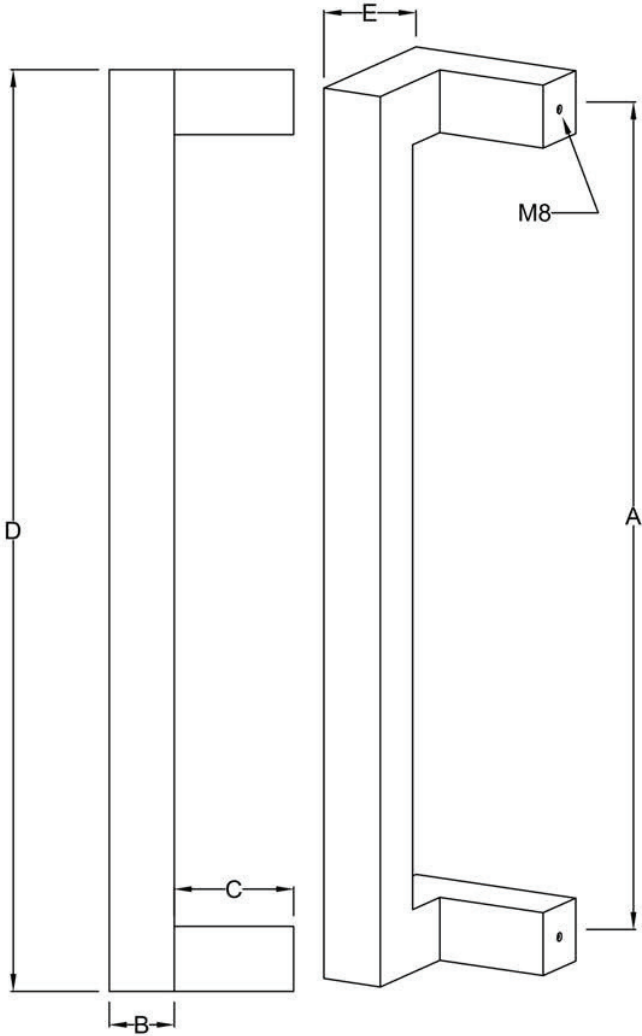

Fixing centres	Diameter	Clearance from door	Overall Length	Offset
A	B	C	D	E
300mm	25 x 25mm	40mm	325mm	90mm
400mm	25 x 25mm	40mm	425mm	90mm
600mm	25 x 25mm	40mm	625mm	90mm
800mm	25 x 25mm	40mm	825mm	90mm

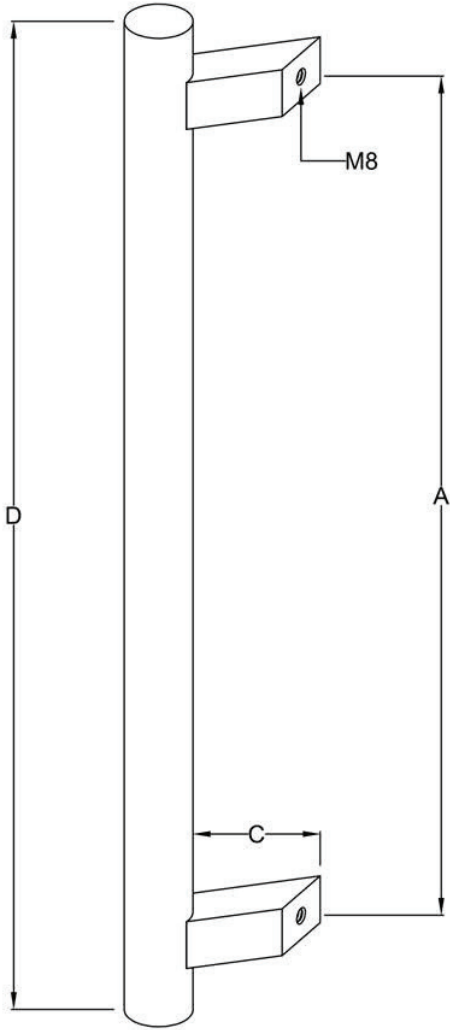
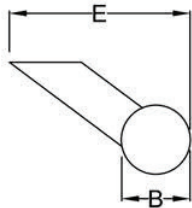

Fixing centres	Diameter	Clearance from door	Overall Length	Offset
A	B	C	D	E
300mm	32mm	35mm	380mm	82mm
450mm	32mm	35mm	530mm	82mm
600mm	32mm	35mm	680mm	82mm
800mm	32mm	35mm	880mm	82mm
1000mm	32mm	35mm	1080mm	82mm

Handle Projection = B + C



JAECO

Jaeco Industries Ltd
7 Neilpark Drive, East Tamaki
Auckland 2013

P: 09 636 6421 | F: 09 636 4835

WWW.JAECO.CO.NZ